

Contact information

Company:	Name:
Street:	Surname:
Zip-code:	Phone:
City:	E-mail:
Country:	Date:
Project Reference:	

Information about type of manipulation

1. Layer information

How many boxes the customer needs to grip at a time?	1 <input type="checkbox"/>	2 <input type="checkbox"/>	3 <input type="checkbox"/>	Other ()	All layer <input type="checkbox"/>
How many boxes the customer needs to release at a time?	1 <input type="checkbox"/>	2 <input type="checkbox"/>	3 <input type="checkbox"/>	Other ()	All layer <input type="checkbox"/>
Layer length (mm):	Max.	Min.	Layer width (mm):	Max.	Min.
Minimum coverage of the layer:	100% <input type="checkbox"/>	75% <input type="checkbox"/>	50% <input type="checkbox"/>	25% <input type="checkbox"/>	Other (%)

2. Type of manipulation

De-palletizing

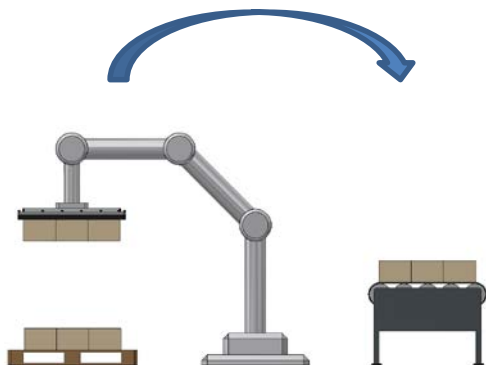

Palletizing

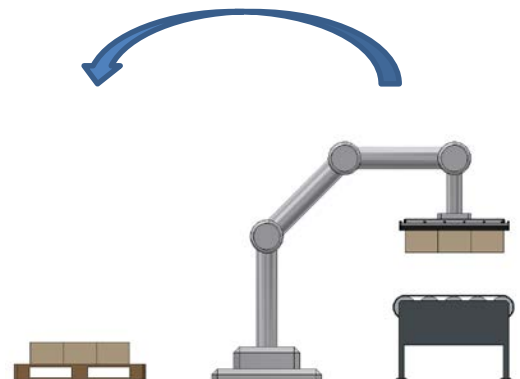

3. Direction of manipulation

Horizontal

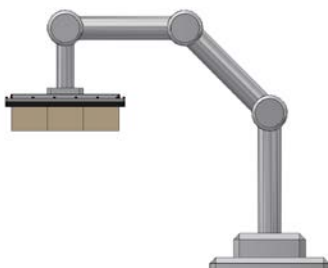

Vertical



Vacuum gripping systems KVG-KVGL
Application form boxes

4. Does the customer needs to handle other parts in addition to the workpiece?

Yes No

Example of other parts:

Pallet

Length (mm):	Max.	Min.
Width (mm):	Max.	Min.
Weight (kg):	Max.	Min.
Material:		

Interlayer

Length (mm):	Max.	Min.
Width (mm):	Max.	Min.
Weight (kg):	Max.	Min.
Material:		

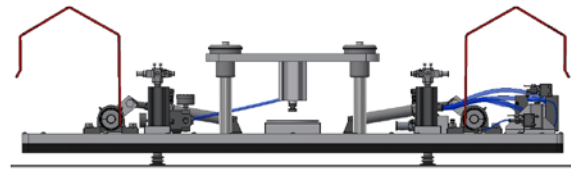
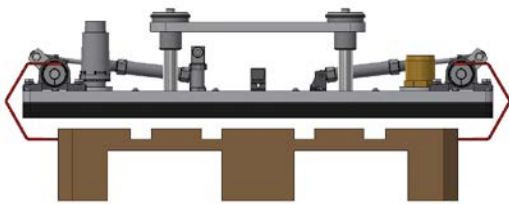

Other

Specify:

Information about product

5. Form and dimensions of the gripping surface.

Gripping surface: Clean Dirty Dry Wet Flat Rough
 Material: Metal Wood Cardboard Plastic Other
 Surface density: Dense Low-porous High-porous

6. Are there any openings on the gripping surface?

Yes No

If yes, we need all these information: Drawings of the openings Images

An example of the opening:



7. The rigidity of the gripping surface.

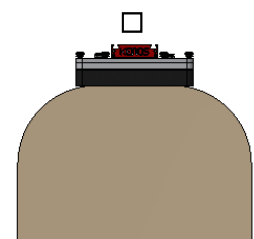
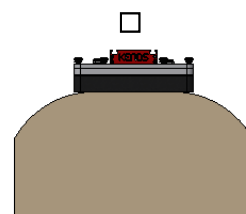
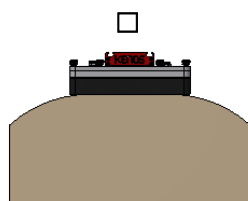
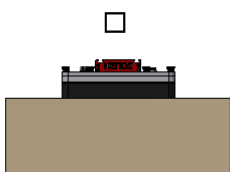

8. Gripping surface

A single and continuous
Gripping surface
Go to the step 9

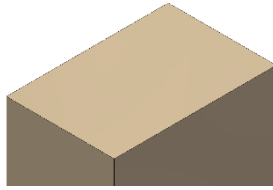

Gripping surface divided.
But closed with tape
Go to the step 9

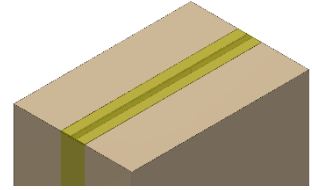

Gripping surface divided and
opened
Go to the step 10

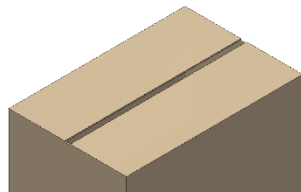

9. Dimensions of the single and continuous gripping surface or divided but closed with tape.

Length (mm):	Max.	Min.
Width (mm):	Max.	Min.
Height (mm):	Max.	Min.
Weight (kg):	Max.	Min.

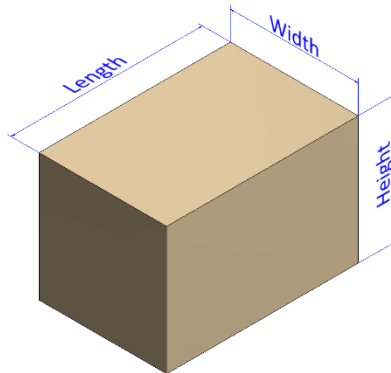

Other shape
Specify:

10. Dimensions of the divided and opened gripping surface.

Length (mm):	Max.	Min.
Width (mm):	Max.	Min.
Height (mm):	Max.	Min.
LA (mm):	Max.	Min.
LF (mm):	Max.	Min.
Weight (kg):	Max.	Min.

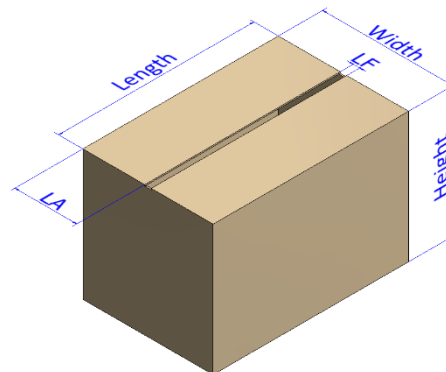

Other shape
Specify:

11. Enclosures

Drawings Photos Samples Other